

Схема электрическая принципиальная PA200-8 (28.05.04)

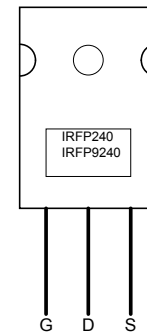
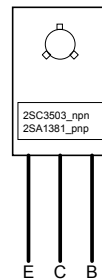
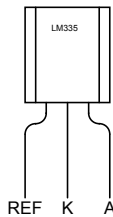
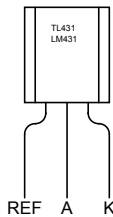
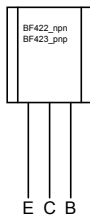
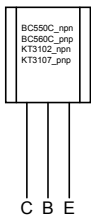
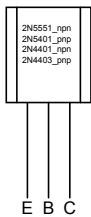
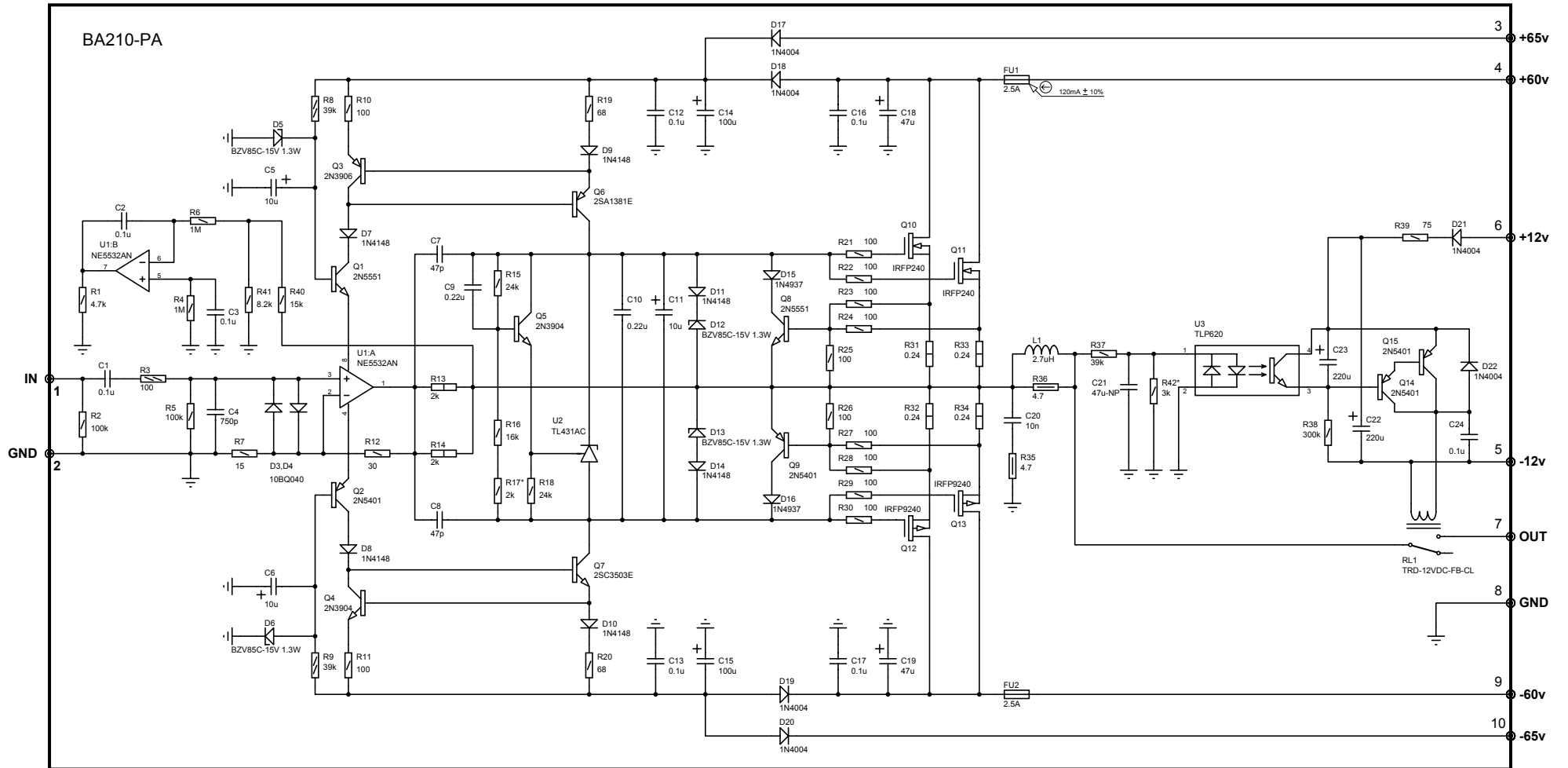

1.\* R17-установить при настройке

2.R42 устанавливается только в комбоусилителе BA210R.